

RECOMMENDED PCB LAYOUT(TOP VIEW)
(GENERAL TOLERANCE ± 0.05)

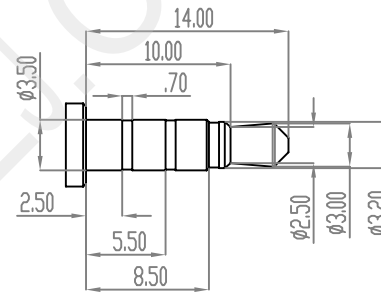

φ 3.50mm 4 POLE PLUG
DETAIL DRAWING(2/1)

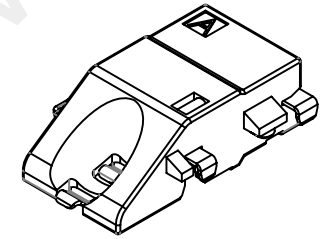
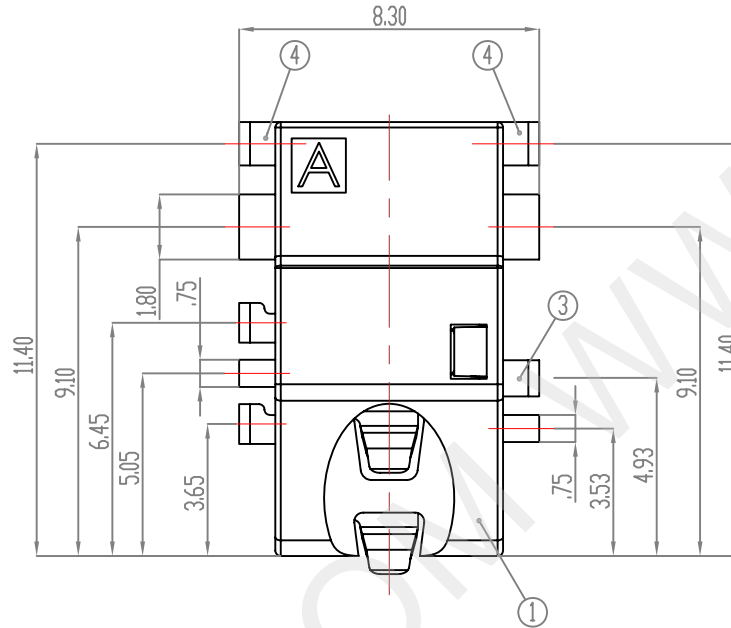
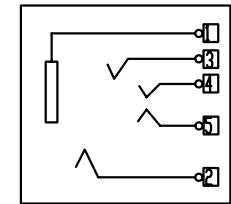

SCHEMATIC

5	TERMINAL 4	COPPER ALLOY	——	Au PLATED
4	TERMINAL 3	COPPER ALLOY	——	Au PLATED
3	TERMINAL 2	COPPER ALLOY	——	Au PLATED
2	TERMINAL 1	COPPER ALLOY	——	Au PLATED
1	HOUSING	HIGH TEMP	BLACK	UL 94V-0
NO.	DESCRIPTION	MAT. L	COLOR	REMARK



深圳市华宇创精密电子有限公司

TOLERANCE: X.X ±0.30 X.XX ±0.25 X.XXX ±0.15 X.' ±2' X.X' ±0.5'	DRAWN BY : 陈一鸣	DATE : 2014-02-23	PART NAME: 3.5耳机座PJ-3016
	CHECKED BY: 马跃	DATE : 2014-02-23	PART NO. HVC-PJ3016-200
 UNIT: mm [inch] SCALE:1:1 SIZE: A4	APPROVED BY: 邱国夷	DATE : 2014-02-23	DRAW NO.: HVC-PJ13092401
			SHEET NO. 1 OF 2

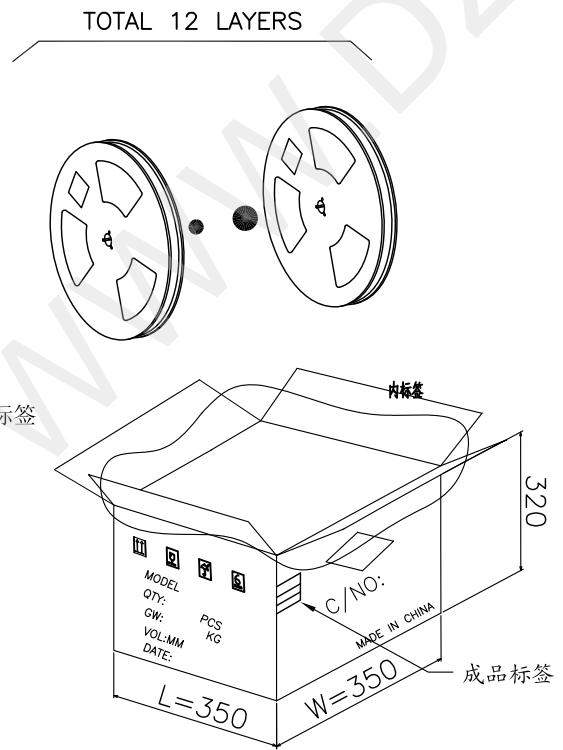
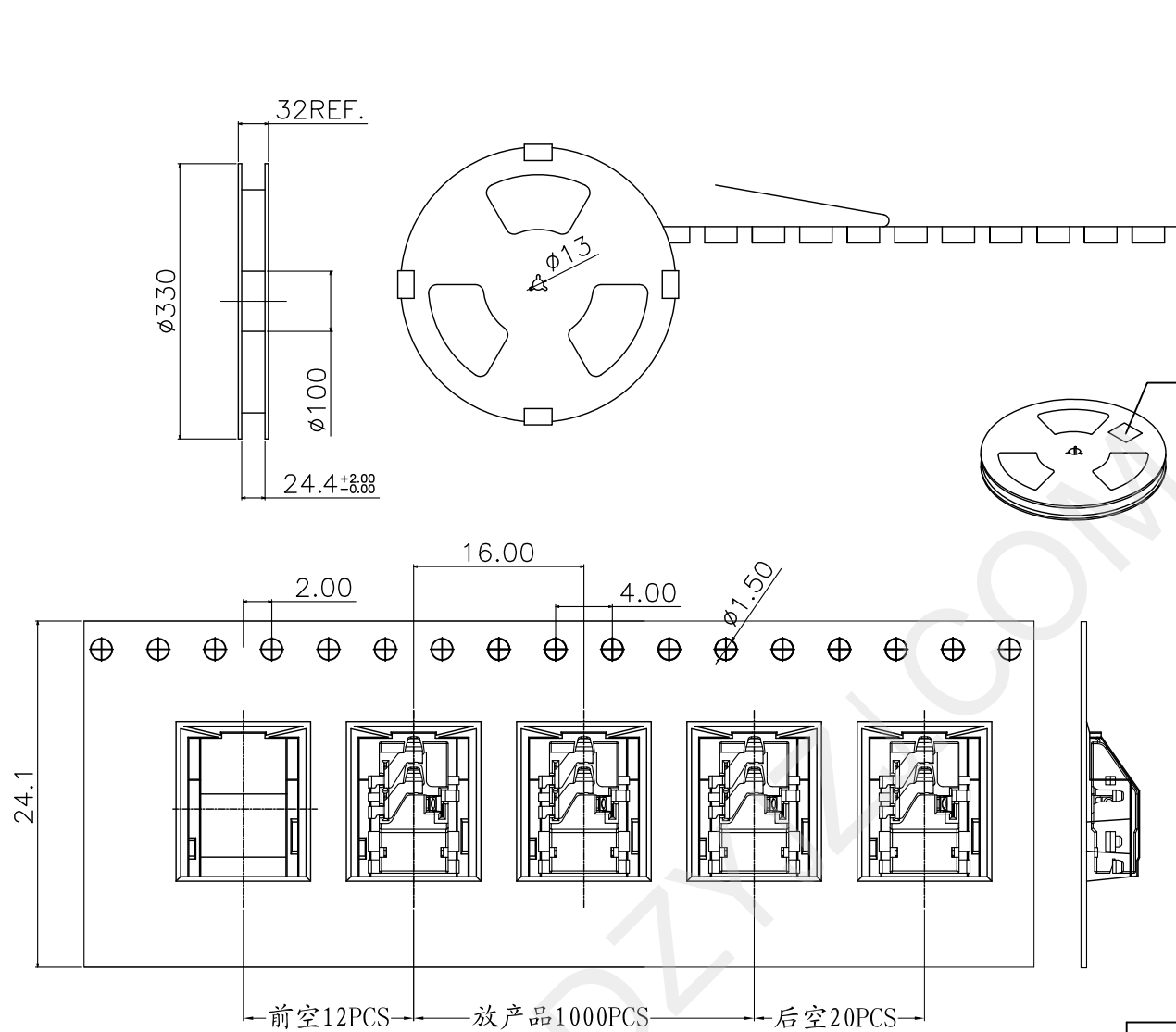

1. 材质要求:
- 1.1 纸箱的材质要求为B-B; 外形尺寸为350*350*320MM;
 - 1.2 卷盘的材质为PVC; 卷盘的外形尺寸为 $\phi 330 \times 30.4$;
 - 1.3 卷带的材质为PVC; 卷带的外形尺寸为30200*24.1*2.7mm
2. 包装要求:
- 2.1 将卷带放入包装机后, 前空12PCS, 后放产品1000PCS, 再后空20PCS; 上带留300MM长度。
 - 2.2 将包装好的产品从包装机上取下并包装好;
 - 2.3 把累叠好的10盘叠放入纸箱中共计10Kset;
 - 2.4 把包装好的成品打包封箱, 并在纸箱外贴上标签

 深圳市华宇创精密电子有限公司			
TOLERANCE: X.X ±0.30 X.XX ±0.25 X.XXX ±0.15 X' ±2' X.X' ±0.5'	DRAWN BY : 陈一鸣	DATE : 2014-02-23	PART NAME: 3.5耳机座PJ-3016
	CHECKED BY: 马跃	DATE : 2014-02-23	PART NO. HVC-PJ3016-200
UNIT: mm [inch] SCALE:1:1 SIZE: A4	APPROVED BY: 邱国夷	DATE : 2014-02-23	DRAW NO: HVC-PJ13092401
			SHEET NO. 2 OF 2